

FRONT ELEVATION

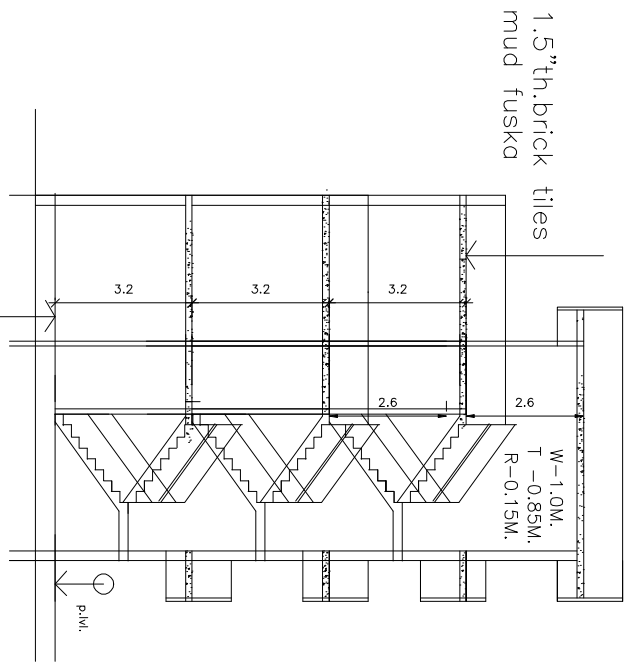

SECTION AA'

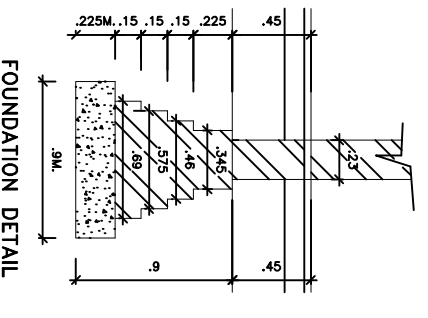

FOUNDATION DETAIL

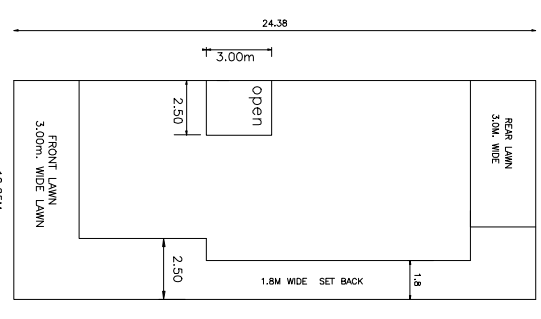

SITE PLAN

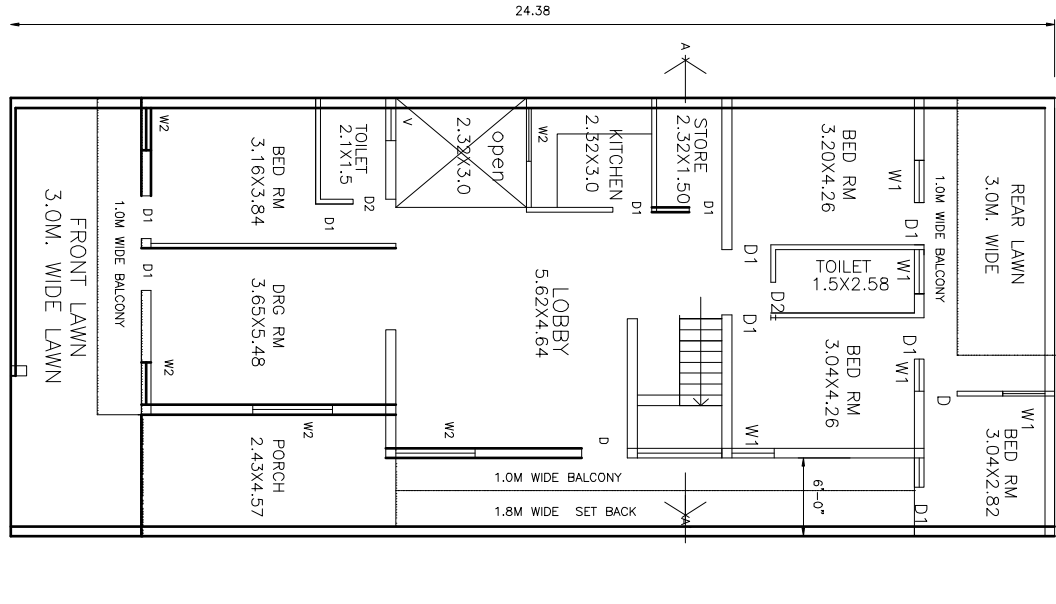

GROUND FLOOR PLAN

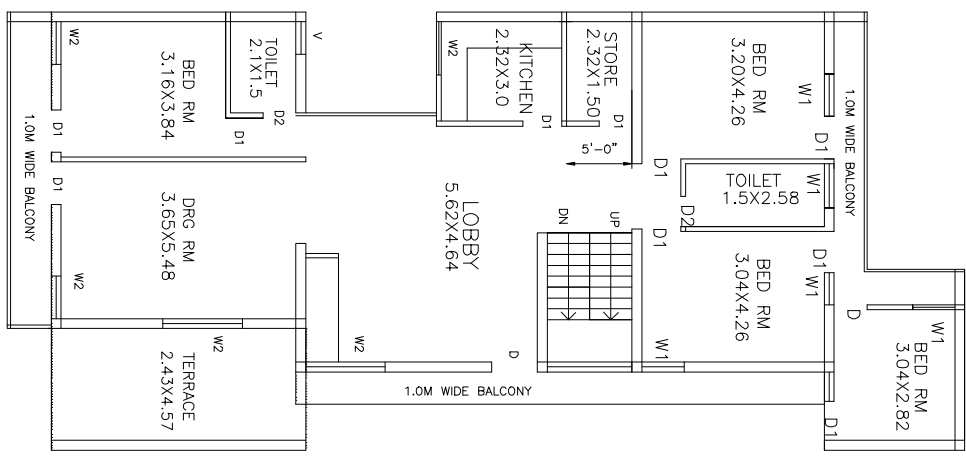

FIRST FLOOR PLAN

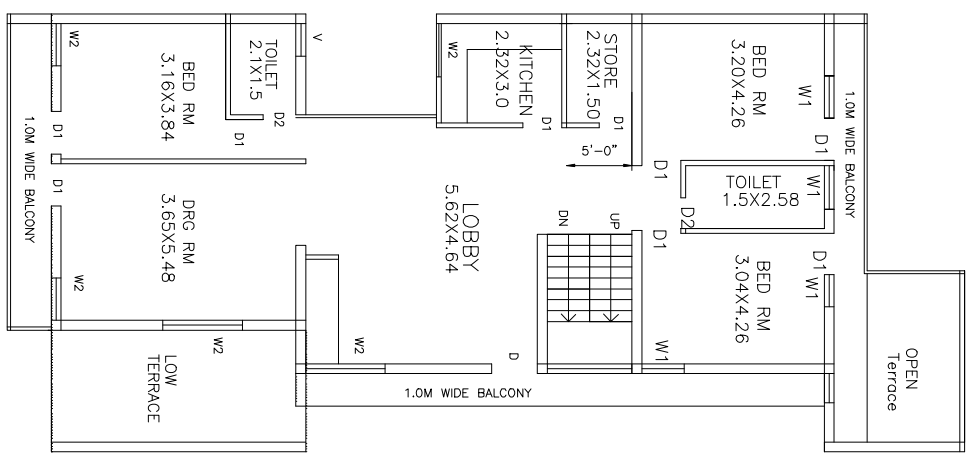

SECOND FLOOR PLAN

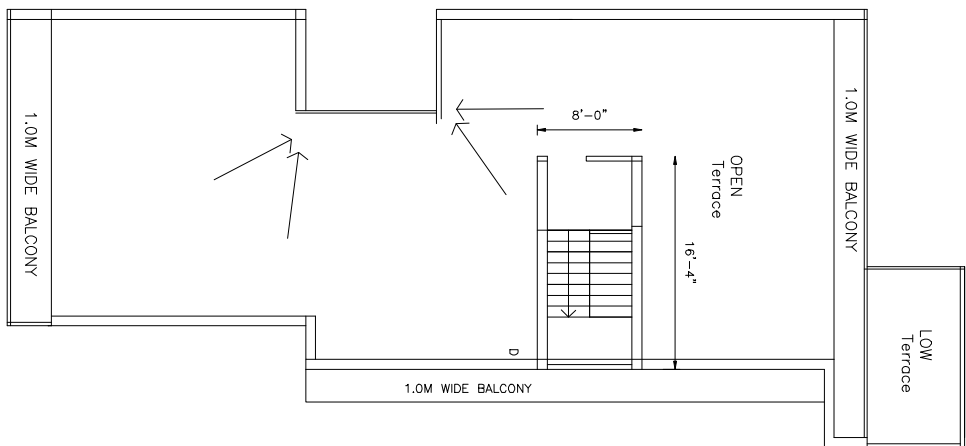

TERRACE FLOOR PLAN

PERM. GROUND COV. 172.43 SQ.M.  
 PROP. GROUND COV. 156.00 SQ.M.  
 PERM. F.A.R. 462.50 SQ.M.  
 PROP. F.A.R. 459.40 SQ.M.

AREA CHART

- (1) TOTAL AREA OF PLOT = 249.90 SQ.M.)
- (2) OPEN AREA ON G.F. =
- 10.25 X 3.0 = 30.75 SQM
- 06.25 X 3.0 = 18.75 SQM
- 12.57 X 1.8 = 22.63 SQM
- 2.50 X 5.71 = 14.27 SQM
- 2.50 X 3.0 = 7.50 SQM

TOTAL OPEN AREA ON G.F. = 93.90 SQ.M.  
 COVD. AREA ON GROUND/FLOOR = 156.00 SQ.M.  
 COVD. AREA ON FIRST FLOOR = 156.00 SQ.M.  
 COVD. AREA ON SECOND FLOOR = 147.40 SQ.M.  
 TOTAL COVD. AREA = 459.40 SQM  
 COVD. AREA ON MUMNTY = 12.11 SQ.M.

SIZE OF DOORS & WINDOWS

D	DOOR	1.0M.X2.1M.
D1	DOOR	0.9M.X2.1M.
D2	DOOR	0.75M.X2.1M.
W	WINDOWS	1.2M.X1.8M.
W1	WINDOW	.75M.X1.0M.